

Technische fiche :

# MRT 2660 E



 **MANITOU**  
HANDLING YOUR WORLD

Capacities		Metrisch
Max. capacity		6000 kg
Max. lifting height		25.90 m
Max. outreach		21.70 m
Weight and dimensions		
Overall length (with forks)	l1	9.28 m
Length to face of forks	l2	8.08 m
Overall width	b1	2.50 m
Overall height	h17	3.10 m
Overall cab width	b4	0.96 m
Ground clearance	m4	0.38 m
Wheelbase	y	3.05 m
Tilt-up angle	a4	12 °
Tilt-down angle	a5	110 °
Turret rotation		360 °
Overall weight		18000 kg
Forks length / width / section	l / e / s	100 mm x 1200 mm x 60 mm
Wheels		
Standard tyres		445/65 R22,5
Drive wheels (front / rear)		2 / 2
Steering mode		2 wheel steer, 4 wheel steer, Crab mode
Stabilisers		
Stabs Type		Telescopic Duplex
Controls with stabs		Stabs Commands Individual or Simultaneous
Electric circuit		
Number of batteries / Battery		2 x 12 V
12V Battery capacity		120 Ah
Battery starting current		(EN)850 A
Engine/Battery		
Battery capacity		105 Ah
Battery nominal voltage		624 V
Battery max. voltage		700 V
Battery technology		Lithium-ion
Battery energy		65 kWh
Drive motor power		107 kW
Hydraulic motor power		84 kW
Transmission		
Transmission type		Electrical
Number of gears (forward / reverse)		2 / 2
Max. travel speed		38 km/h
Parking brake		Automatic negative parking brake
Service brake		Oil-immersed multi-discs braking on front & rear axles
Hydraulics		
Hydraulic pump type		Fixed displacement piston
Hydraulic flow		175 l/min
Hydraulic Pressure		350 bar
Hydraulic tank capacity		200 l
Miscellaneous		
Steering wheels (front / rear)		2 / 2
Controls		2 Joysticks
Safety cab homologation		Cabin ROPS - FOPS Level 2
Attachment recognition system (E-Reco)		Standard

## MRT 2660 e - Tekening met afmetingen

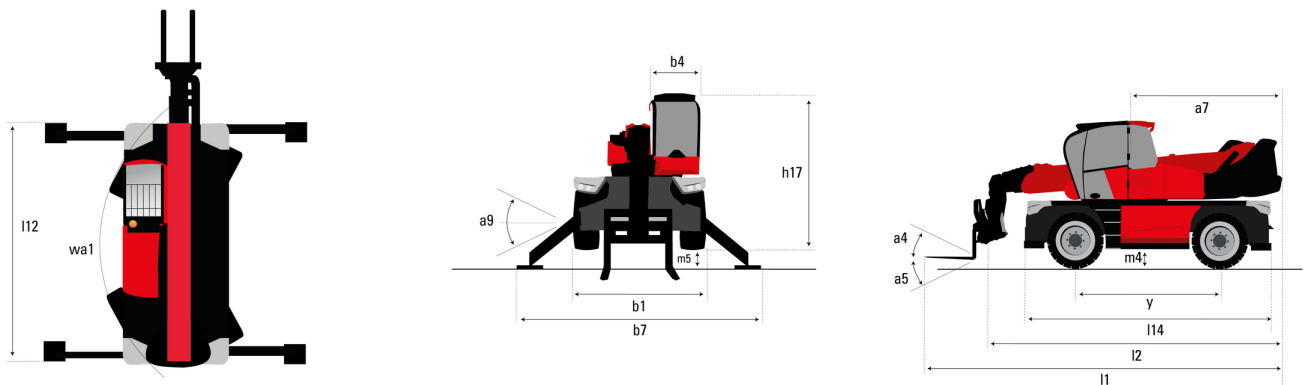

Andere gegevens		Metrisch
Length of frame	l14	5.69 m
Wheelbase	y	3.05 m
Ground clearance	m4	0.38 m
Counterweight offset (turret at 90°)	a7	2.97 m
Tilt-up angle	a4	12 °
Tilt-down angle	a5	110 °
Overall length at stabilisers	l12	5.30 m
External turning radius (over tyres)	Wa1	4.46 m
Overall width with stabilisers extended	b7	5.78 m
Overall height	h17	3.10 m
Frame levelling corrector	a9	+/- 7 °
Ground clearance under front tires on stabilizers	m5	0.43 m

## MRT 2660 e - Lastendiagram

Machine on tyres with forks Metric

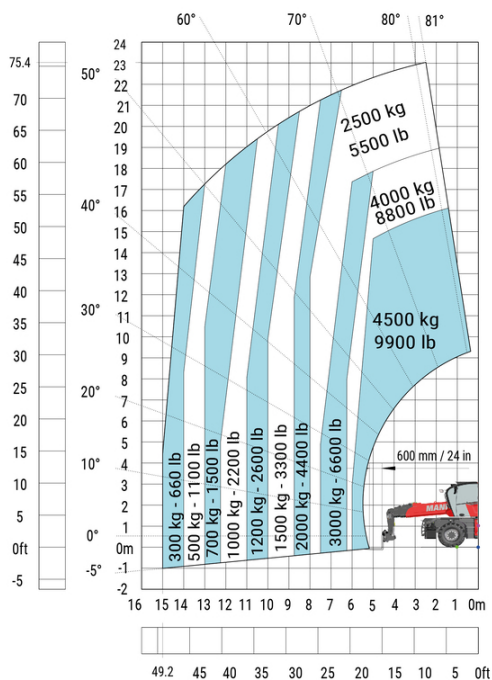

Machine on lowered stabilisers with forks (CAF) Metric

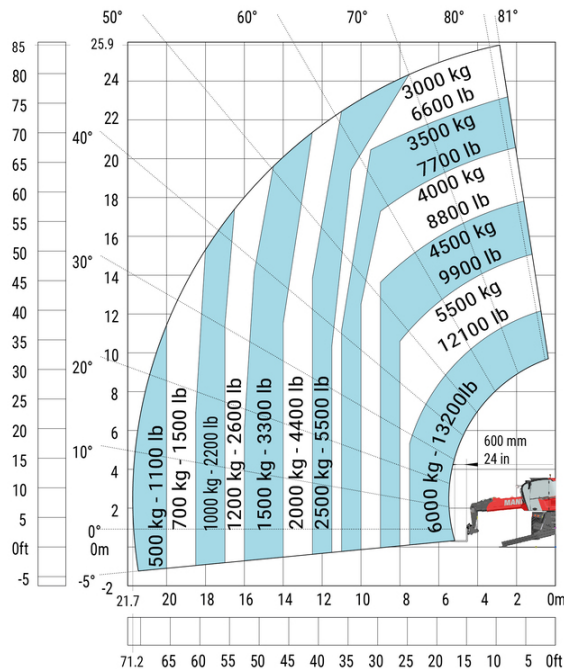

Machine on lowered stabilisers with winch 6000 kg (Metric) Machine on lowered stabilisers with 1500 kg jib with winch (Metric)

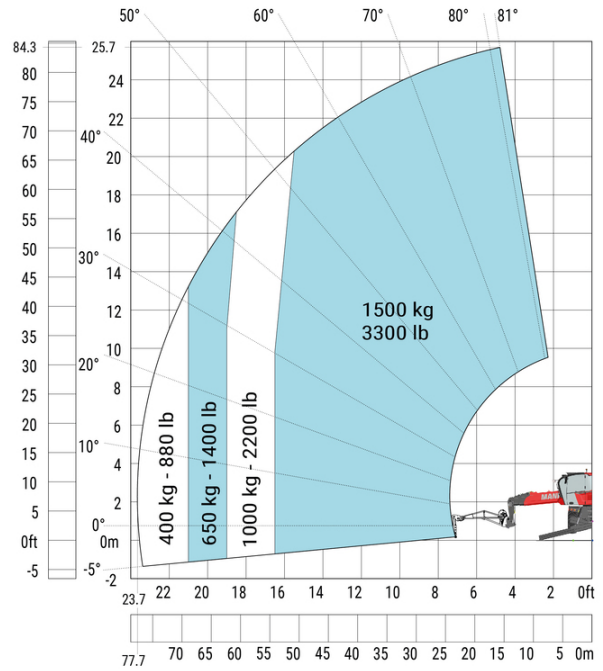
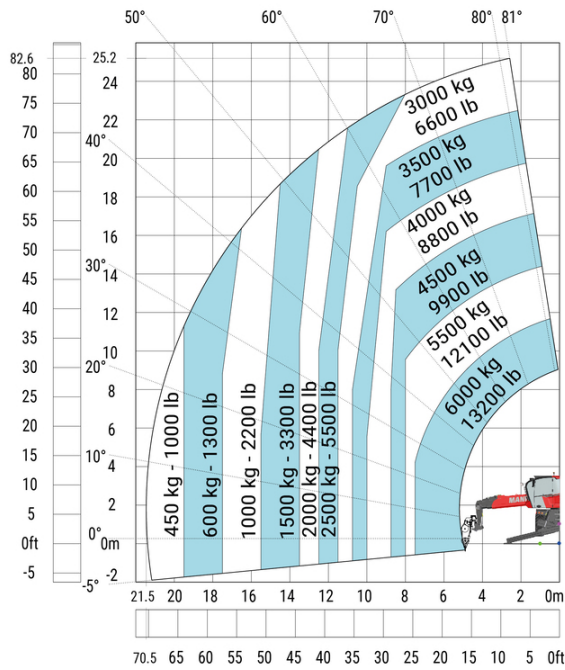

Machine on lowered stabilisers with extensible jib with winch (Metric)

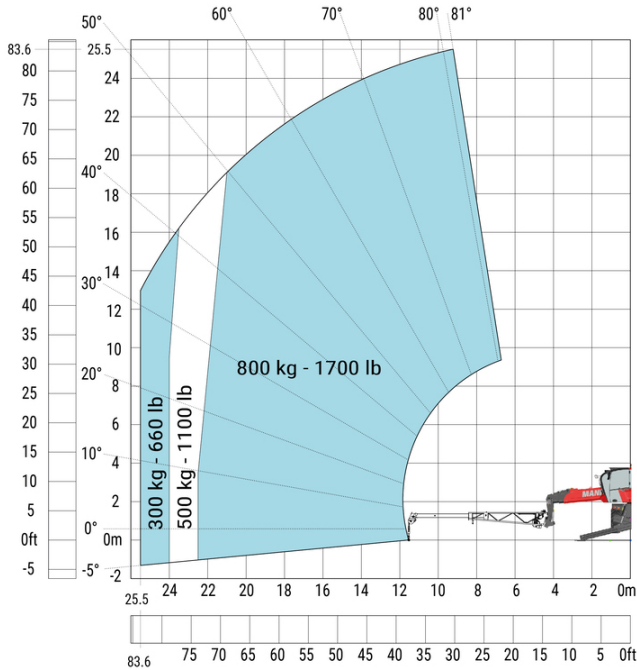

Machine on lowered stabilisers with hook 6000 kg (Metric)

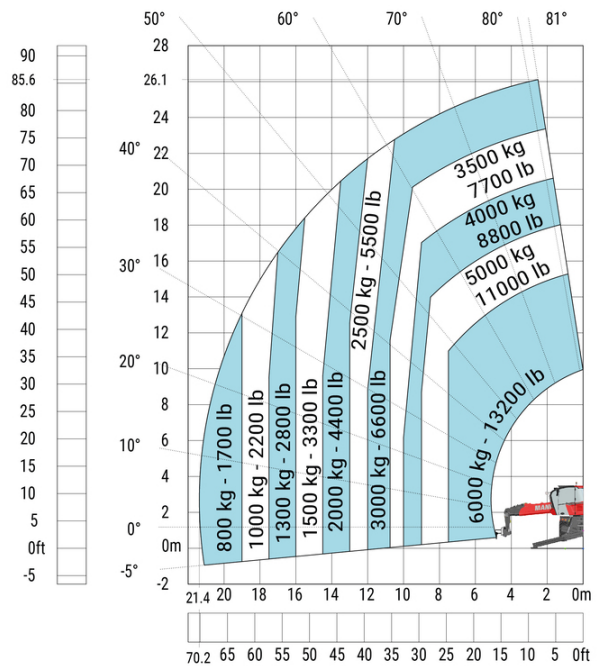

Machine on lowered stabilisers with 365 kg platform Metric Machine on lowered stabilisers with 1000 kg platform Metric



Machine on lowered stabilisers with 3D positive Metric

Machine on lowered stabilisers with 3D positive / negative Metric

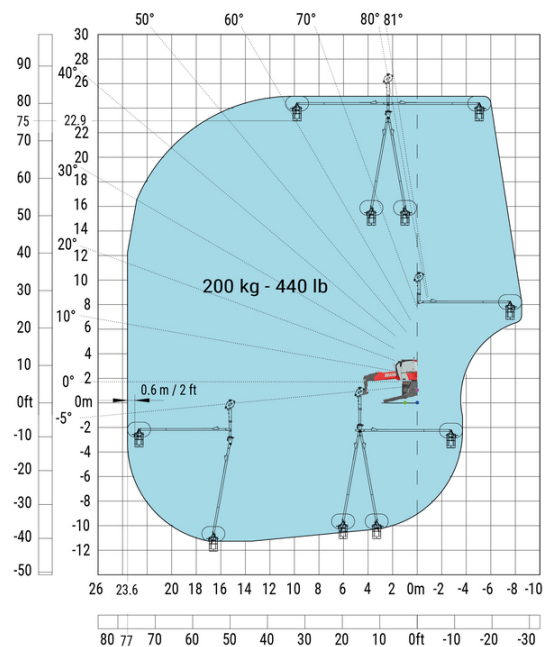

Uitrusting

Standaard

Optioneel

Additional battery high voltage 65 kWh

Extra generator 18.4 kW

## Equipment: E-xtra generator 18.4 kW

Capacities		Metrisch
Engine oil		3.40 l
Fuel tank		65 l
Engine		
Engine brand / nom		Yanmar / Stage V / Tier 4
Engine model		3TNV80F-ZXKMU
Number of cylinders - Capacity of cylinders		3 - 1267 cm <sup>3</sup>
Max. torque		74.50 Nm
Power (kW)		18.40 kW
Engine rotation		2800 rpm
Engine rotation (min)		1900 rpm
Engine cooling system		Water cooled
I.C. Engine power rating		25 Hp



 **MANITOU**  
**HANDLING YOUR WORLD**

**Hoofdkantoor**

B.P. 249 - 430 rue de l'Aubinière

44150 Ancenis Cedex - Frankrijk

Tel.: 00 33 (0)2 40 09 10 11 - Fax: 00 33 (0)2 40 09 10 97

[www.manitou.com](http://www.manitou.com)



Deze brochure beschrijft versies en configuratie-opties voor Manitou-producten die met verschillende apparatuur kunnen worden uitgerust. De uitrusting die in deze brochure wordt beschreven, kan standaard, optioneel of niet leverbaar zijn, afhankelijk van de uitvoering. Manitou behoudt zich het recht voor om de weergegeven en beschreven specificaties op elk moment en zonder kennisgeving vooraf te wijzigen. De fabrikant is niet aansprakelijk voor de gegeven specificaties. Neem voor meer informatie contact op met uw Manitou-dealer. Niet-contractueel document. De productbeschrijvingen kunnen afwijken van de werkelijke producten. De lijst met specificaties is niet allesomvattend. De logo's en visuele identiteit van het bedrijf zijn eigendom van Manitou en mogen niet zonder toestemming worden gebruikt. Alle rechten voorbehouden. De foto's en diagrammen in deze brochure zijn uitsluitend bedoeld voor raadpleging en informatie.

MANITOU BF SA - Naamloze vennootschap met raad van bestuur - Aandeelkapitaal: 39.668.399 euro - 857 802 508 RCS Nantes