

Vertical text on the left edge of the page, likely a barcode or identification number.

MERLO
ROTO70.24

A0323

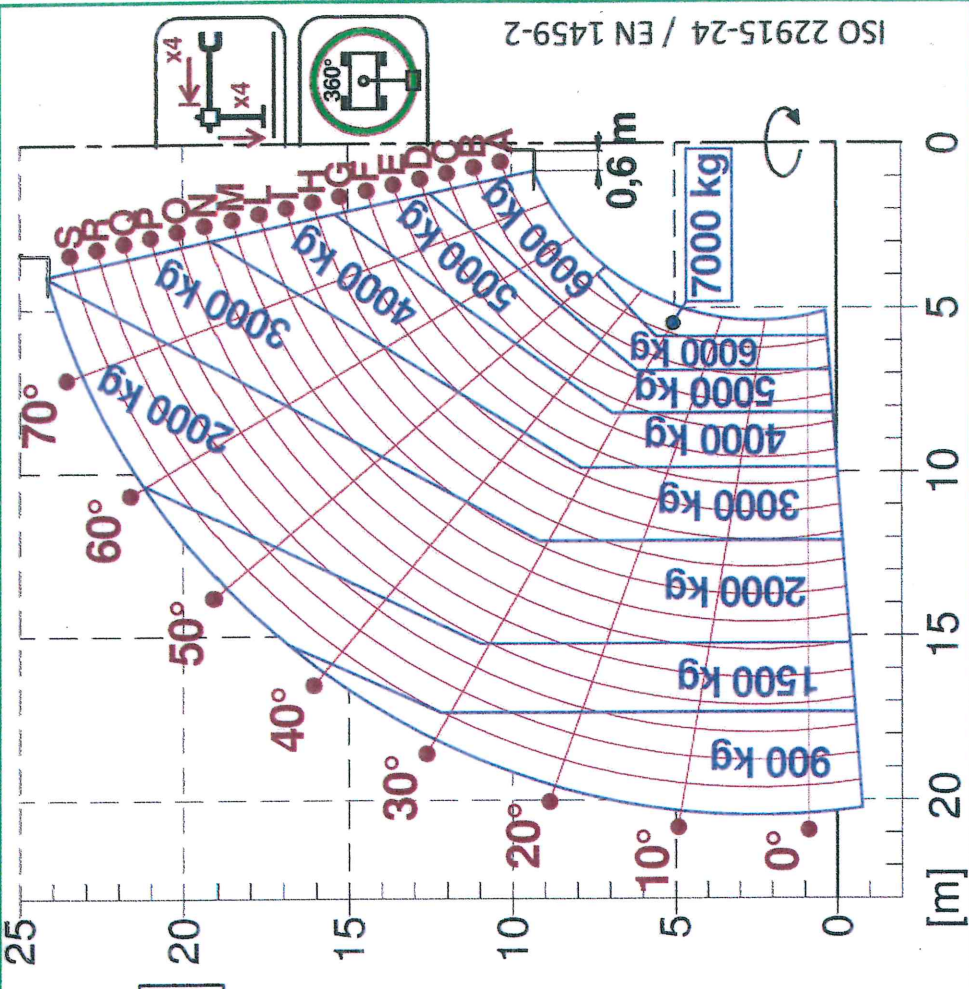
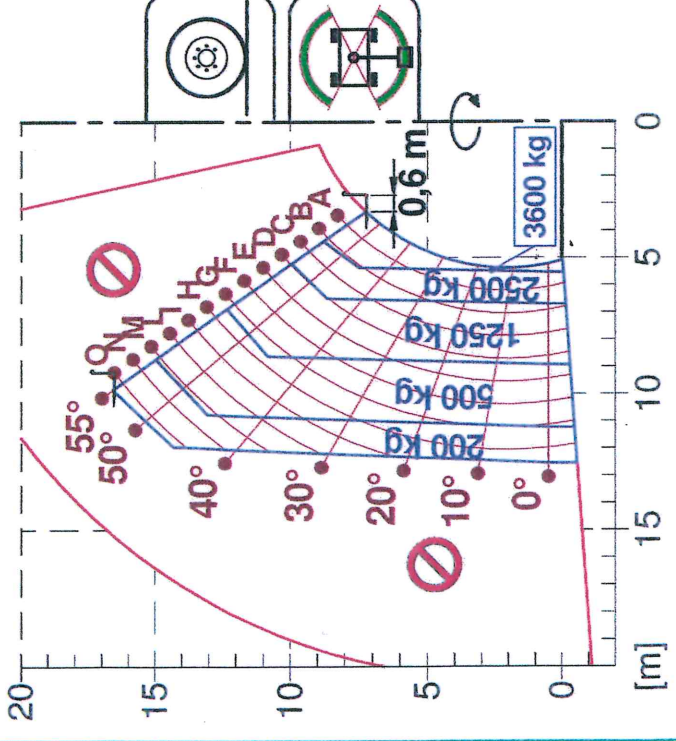
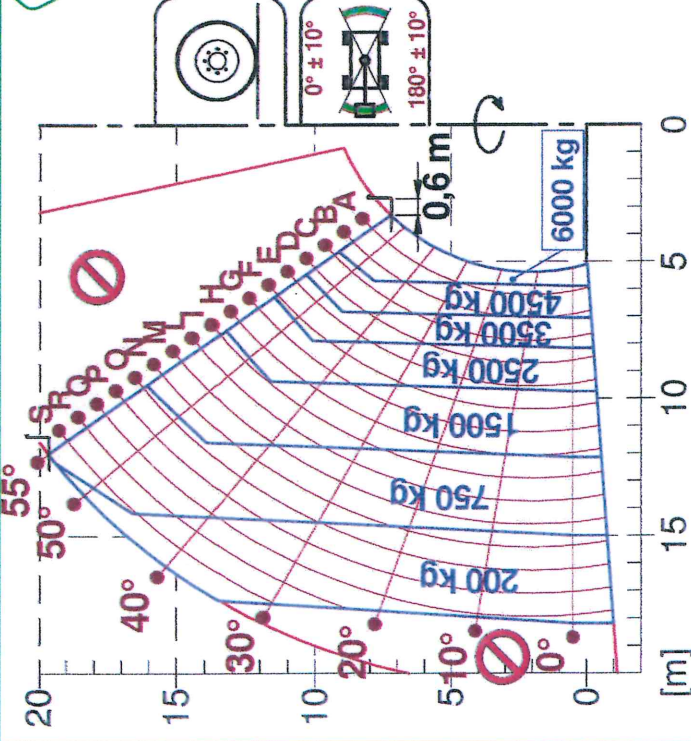

Safety and performance icons including a forklift with a load, a speed limit sign (MAX 12.5 m/s), a target sign (R1), and a 300mm distance marker.

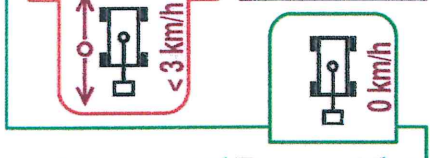
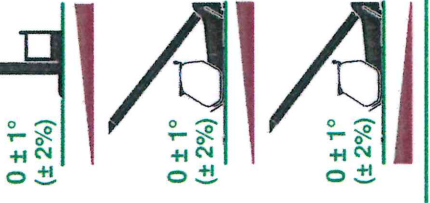

ISO 22915-24 / EN 1459-2

MERLO
ROTO70.24

A1001

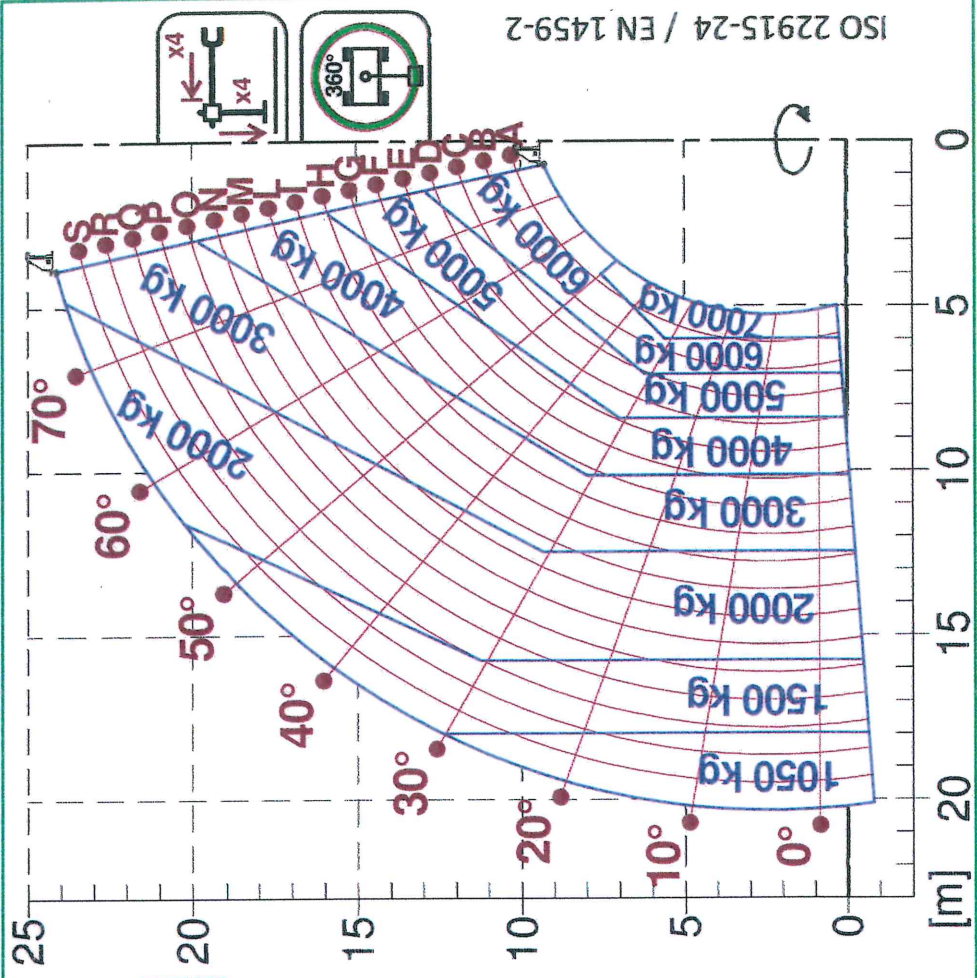
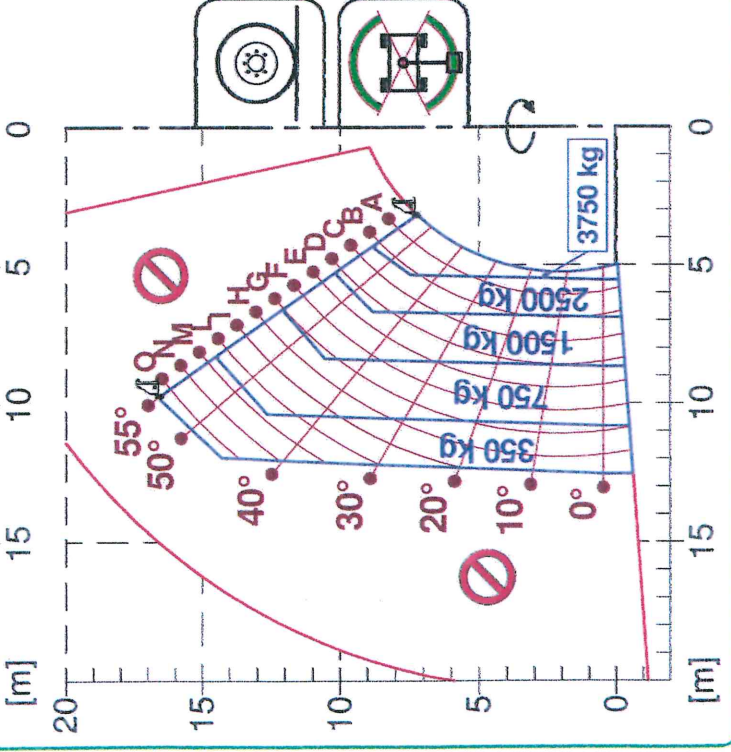
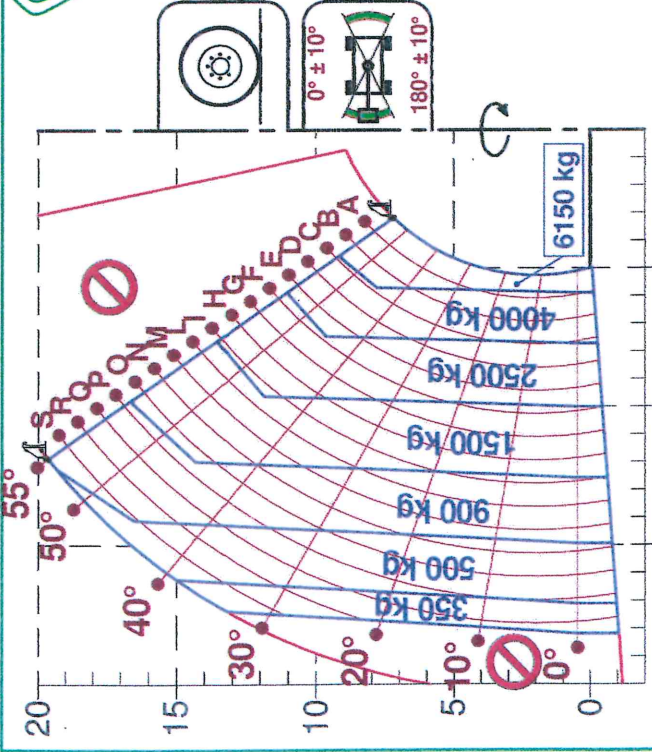





0 ± 1° (± 2%)

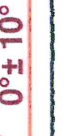

0 ± 1° (± 2%)



0 ± 1° (± 2%)



0 ± 10°



0 ± 10°



MAX

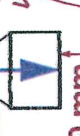

300 mm

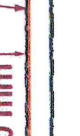

MAX 5° (9%)



MAX 5° (9%)



MAX 9° (16%)



0 km/h





< 3 km/h



R1







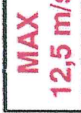

MAX
12,5 m/s

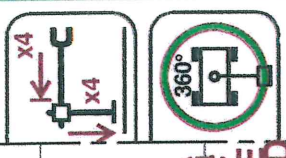

ISO 22915-24 / EN 1459-2

MERLO
ROTO70.24

A1119B

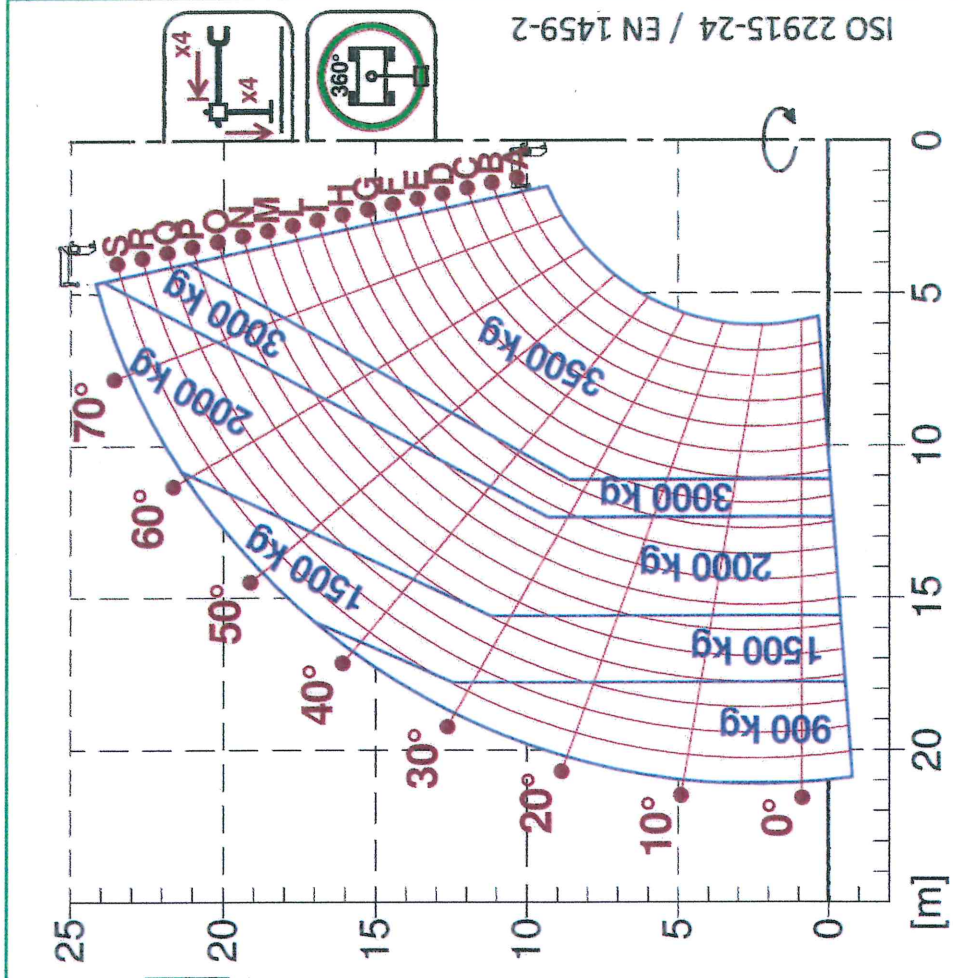
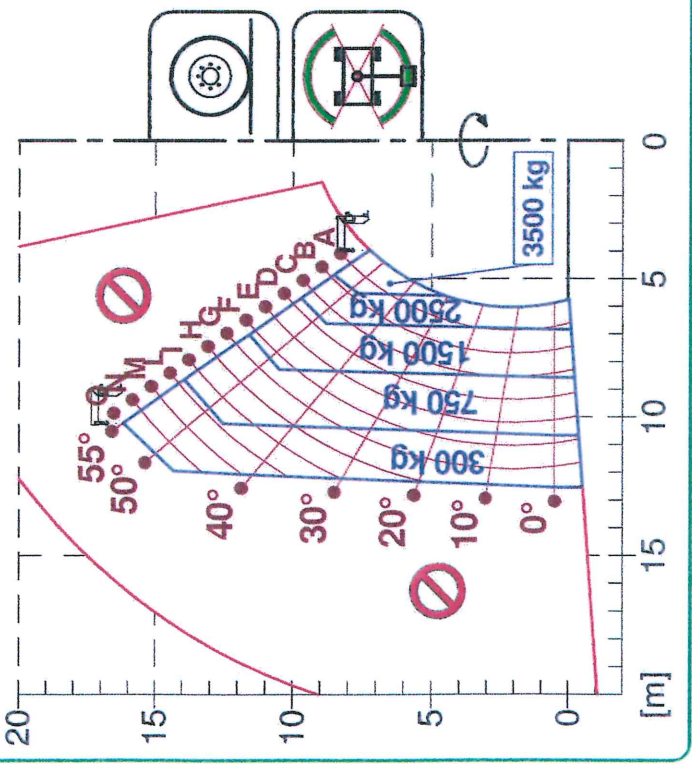
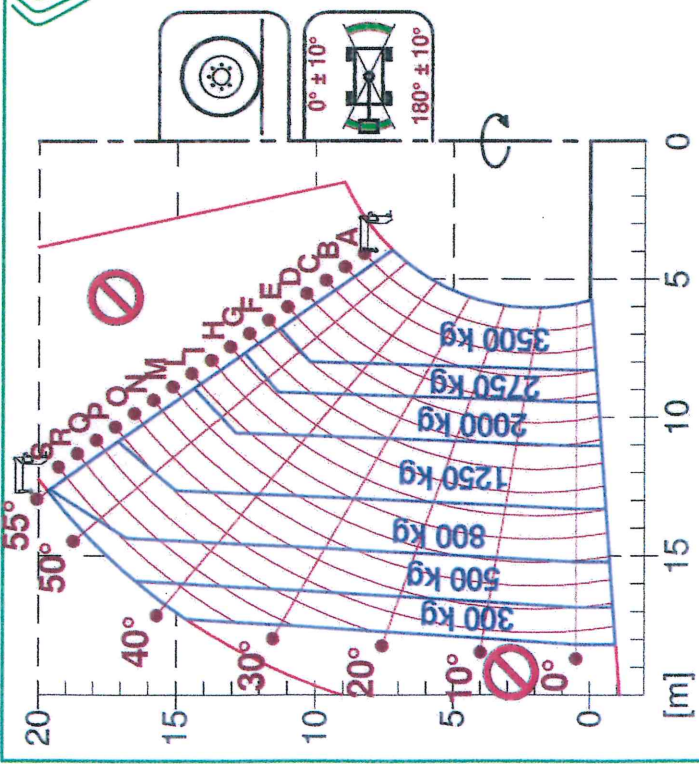

Technical specifications and safety icons:

- 0 ± 1° (± 2%)
- 0 ± 1° (± 2%)
- 0 ± 1° (± 2%)
- 0 ± 10°
- 0 km/h
- < 3 km/h
- MAX
- 0°
- < 50°
- 300 mm
- MAX 5° (9%)
- MAX 5° (9%)
- MAX 9° (16%)
- MAX 12,5 m/s
- R1

ISO 22915-24 / EN 1459-2

MERLO
ROTO70.24

A1321B
A1221B

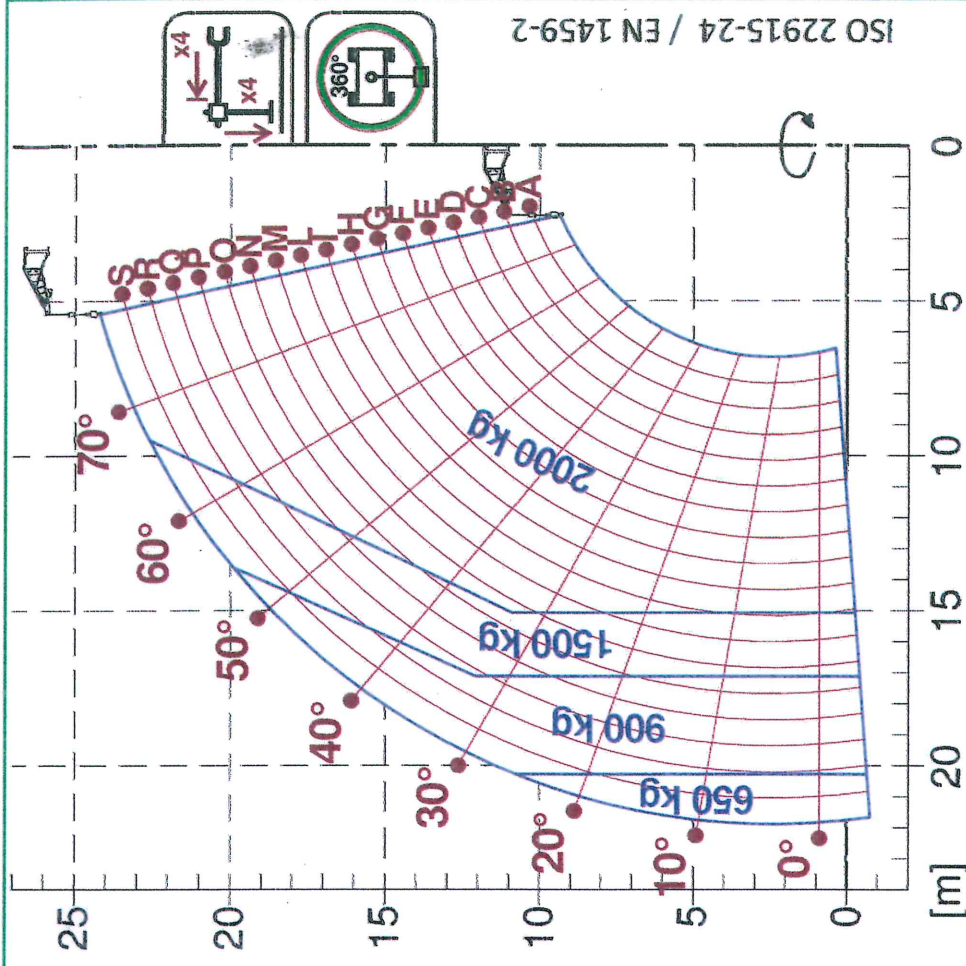
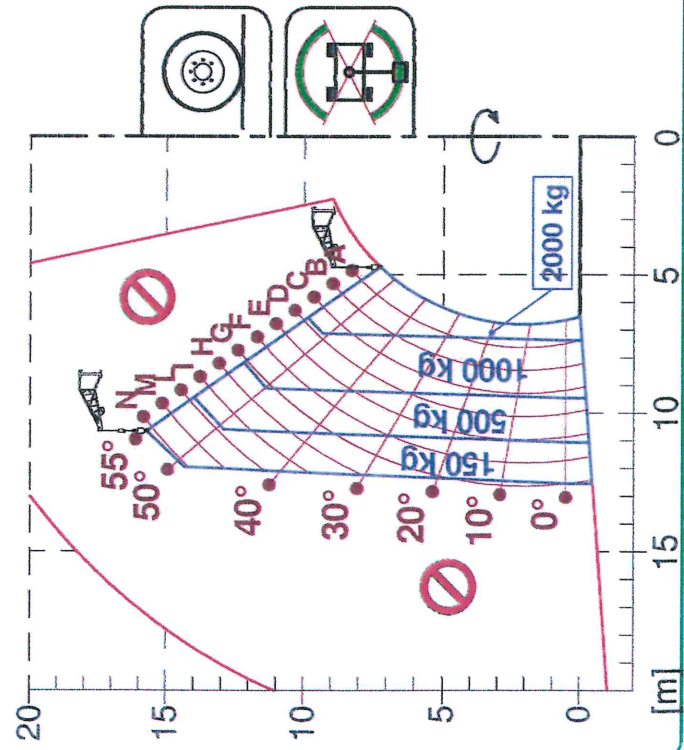
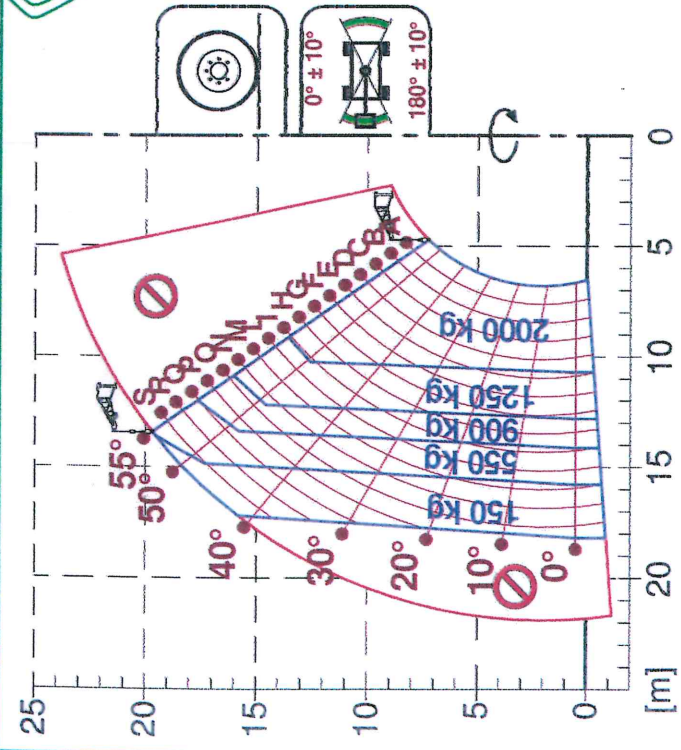

0°
0 km/h

0° ± 1°
(± 2%)
0 km/h

0° ± 10°
< 3 km/h

0°
300 mm

50°
MAX

0° ± 10°

0° ± 10°

MAX 5° (9%)

MAX 5° (9%)

MAX 5° (16%)



MAX 9° (16%)

MAX
12,5 m/s

R1

360°

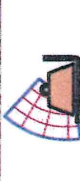
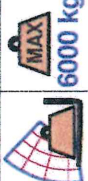
MERLO ROTO70.24

A2769		
A2768		

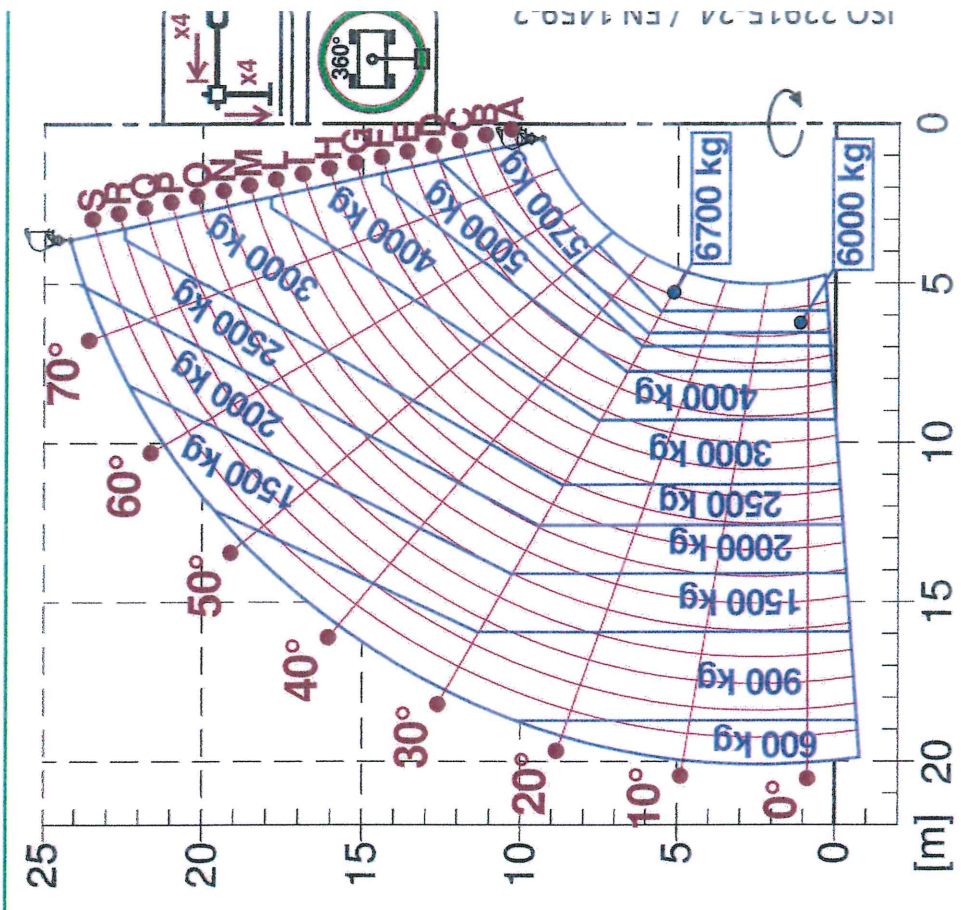
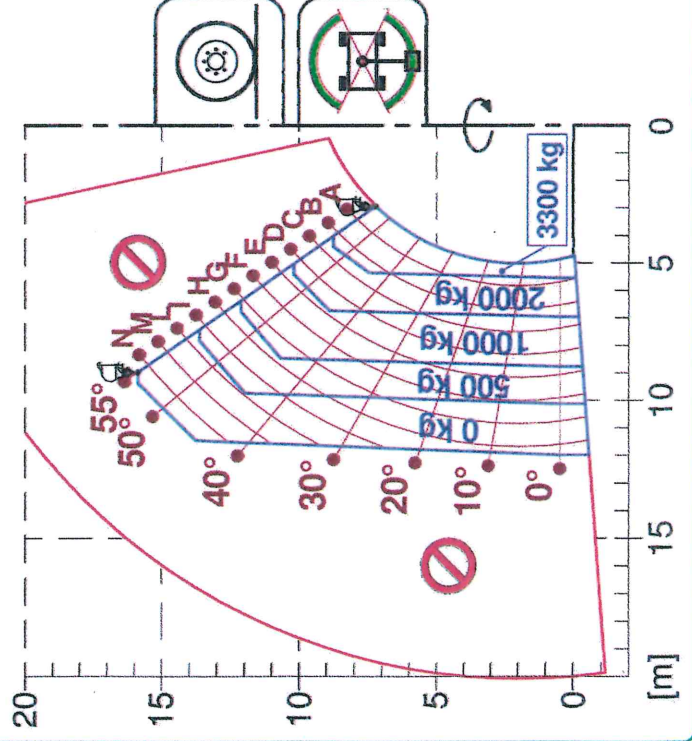
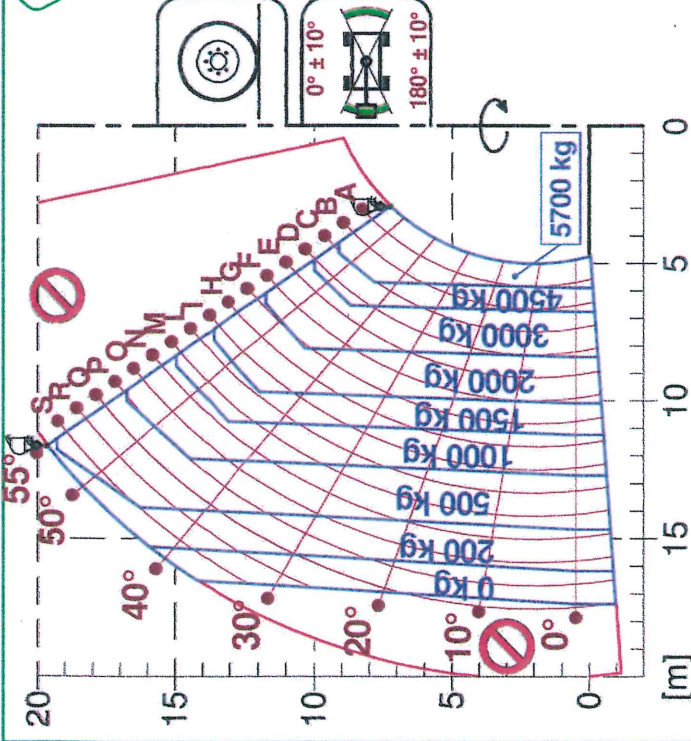



0°

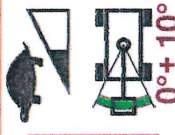

0° ± 10°



< 3 km/h

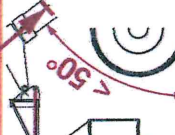

MAX



0°



< 50°



MAX 5° (9%)



MAX 9° (16%)



0 km/h



R1



MAX 12,5 m/s

WERKPLATFORM 800 KG

TABEL LINKS: MACHINIST IN CABINE

TABEL RECHTS: MACHINIST IN WERKPLATFORM

